

ÖZMAK KONVEYÖR CONVEYORS



www.ozmakkonveyor.com

ÖZMAK



**KONVEYÖR
CONVEYORS**

Firmamız endüstriyel, ağır tip bant konveyör imalatı alanında çalışmalarını sürdürmektedir. Tüm konveyörlerimizin imalatı ve imalat için gerekli olan parçaları (tambur, rulo v.b.) kendi bünyemizde üretebilmekteyiz.

Deneyimli çalışan kadromuz ve teknik ekibimiz ile bugün başta madencilik ve inşaat ve beton sanayi gibi bir çok endüstriyel tesisler olmak üzere Türkiye' nin her bir bölgesindeki mevcut sistemlere gerekli çözümlerimizi götürmüş ve ihtiyaçlar doğrultusunda imalâtlarımızı gerçekleştirmiş bulunmaktayız. Gün geçtikçe bu yolda daha sağlam adımlarla yürümeye devam etmekteyiz.

Bu sektörlerde edindiğimiz tecrübeler ile siz değerli müşterilerimiz için ihtiyaçlar doğrultusunda kalıcı çözümler üretmek firma prensibimizdir.

Bant konveyör üniteleri; taş kırma, eleme, yıkama ve stok aralığında çalışan malzemenin taşınmasını ve stoklanmasını sağlayan, genişlik, uzunluk ve kapasite tipleri olan sistemleri hatasız üretebilmekteyiz..



Our company continues its work in the field of industrial, heavy type belt conveyor manufacturing. We can manufacture all our conveyors and the parts required for manufacturing (drum, roller, etc.) in-house.

With our experienced staff and technical team, today we have brought the necessary solutions to the existing systems in every region of Turkey, especially in many industrial facilities such as mining, construction and concrete industry, and have carried out our production in line with the needs. We continue to walk this path with firmer steps day by day.

Our company principle is to produce permanent solutions in line with the needs of our valued customers with the experience we have gained in these sectors.

Belt conveyor units; We can produce error-free systems with width, length and capacity types that enable the transportation and storage of materials working in the range of stone crushing, screening, washing and stocking.

www.ozmakkonveyor.com

ÖZMAK



**KONVEYÖR
CONVEYORS**

Ürünlerimiz & İmalatlarımız Our Products & Manufacturing

- Bant Ruloları
- Konveyör İstasyonları
- Bant Konveyör Kapamaları
- Tahrik ve Kuyruk Tamburları
- Redüktör
- Konveyör Bant Lastiği
- Tape Rolls
- Conveyor Stations
- Belt Conveyor Closures
- Drive and Tail Drums
- Reducer
- Conveyor Belt Tire

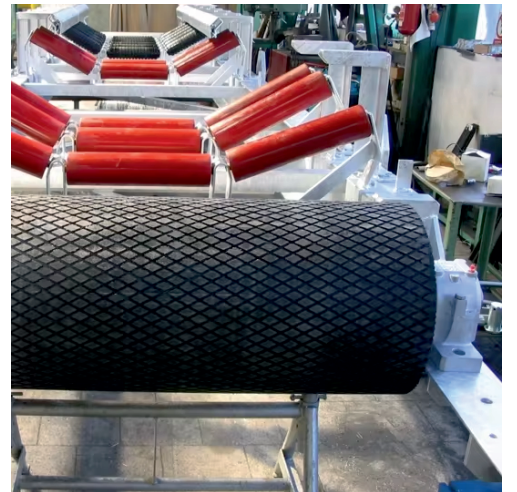

www.ozmakkonveyor.com

ÖZMAK



KONVEYÖR
CONVEYORS

Üretim & Montaj / Production & Assembly

Üretimini yaptığımız rulo veya tamburları her türlü çalışma ortamında çalışacak şekilde tasarlanmış olup , dünya normlarına uygun sistemler ile imal edilmektedir.

kalitesi ve sertifikalarla kanıtlanmış millerin eksiksiz ebatlanması ile yataklanması tamamlanır. Sızdırmazlı ve korozyon önleyici parçaların kaynaklanması ile imalât tamamlanmış olur. Son kalite kontrolden sonra fırın boya ile boyanmaktadır.

The rolls or drums we produce are designed to work in all kinds of working environments and are manufactured with systems that comply with world norms.

Complete sizing and bearing of the shafts, whose quality and certificates are proven, are completed. The production is completed by welding the sealed and anti-corrosion parts. After the final quality control, it is painted with oven paint.

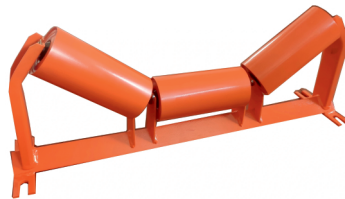
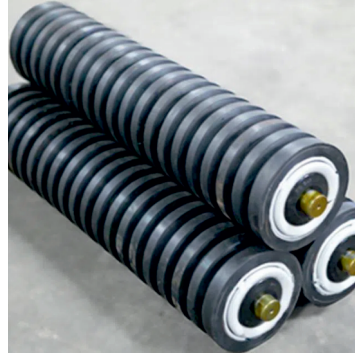

www.ozmakkonveyor.com

ÖZMAK



KONVEYÖR
CONVEYORS

Bant Konveyör Kapama / Belt Conveyor Closing

Bant Kapamaları çalışan sağlığı ve çevre açısından çok önemlidir. Toz' un dışarıya sızmasını büyük ölçüde engeller. Hava şartlarından bant konveyörlerin etkilenmemesi sağlar. 0,75 mm. 10 yıl paslanmaya karşı garantili galvaniz saclarla, özel menteşe sistemi ile dizayn edilerek her noktaya müdahale kolaylığı ile imalat ve montajı yapılır.

Dalgalı çelik levhalar ile gerçekleştirilen kaplama sistemidir. Bakım gerektirmemekle beraber kısa sürede tasarlanıp uygulanır.

Belt Closures are very important for employee health and the environment. It largely prevents dust from leaking out. It ensures that belt conveyors are not affected by weather conditions. 0.75mm. It is designed with galvanized sheets with a 10-year rust-proof guarantee and a special hinge system, and is manufactured and installed with ease of intervention at any point.

It is a coating system made of wavy steel plates. Although it does not require maintenance, it is designed and implemented in a short time.

www.ozmakkonveyor.com

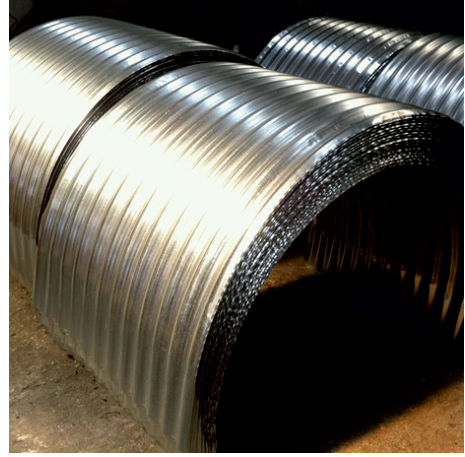

ÖZMAK



KONVEYÖR CONVEYORS

Redüktör / Reducer

ARMUT REDÜKTÖR

Tip	AG-50
Tahvil Oranı	6,1/1
Kw	5,5 - 7,5
Hp	7,5 - 10
Termik Güç Kw	16
Nominal Tork (Nm)	1200
Çıkış Kovanı Ø	50
Giriş Mili Ø	32
Yağ Miktarı Lt.	3
Ağırlık Kg	28

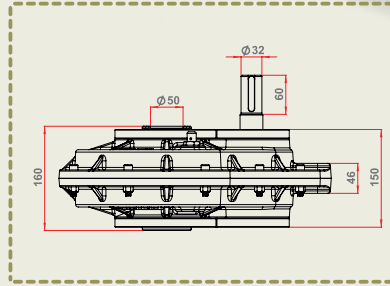
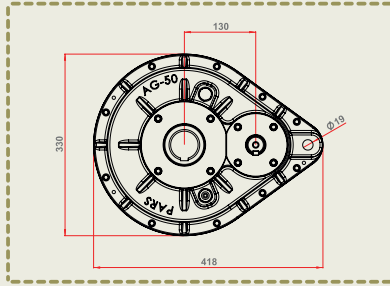

ARMUT REDÜKTÖR

Tip	AG-60
Tahvil Oranı	6,1/1
Kw	7,5 - 11
Hp	10 - 15
Termik Güç Kw	24
Nominal Tork (Nm)	2200
Çıkış Kovanı Ø	60
Giriş Mili Ø	38
Yağ Miktarı Lt.	4
Ağırlık Kg	38

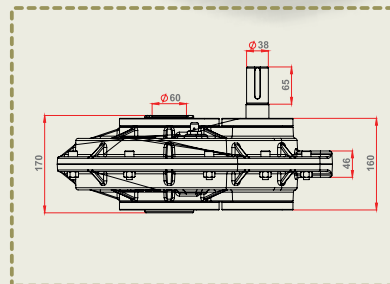
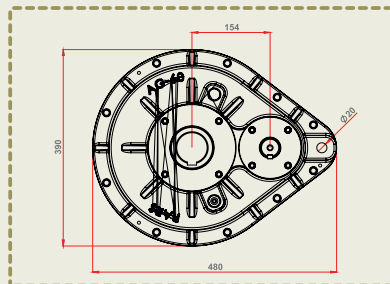

www.ozmakkonveyor.com

ÖZMAK



KONVEYÖR CONVEYORS

Redüktör / Reducer

45 KADEMELİ REDÜKTÖR

Tip	PG-45
Tahvil Oranı	PG Kademeli
Kw	5,5 - 7,5
Hp	7,5 - 10
Termik Güç Kw	20
Nominal Tork (Nm)	1200
Çıkış Kovanı Ø	45
Giriş Mili Ø	28
Yağ Miktarı Lt.	3
Ağırlık Kg	30

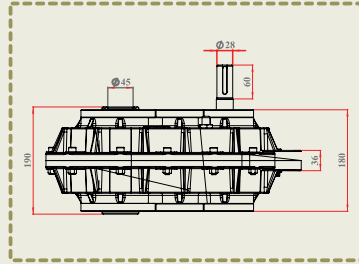
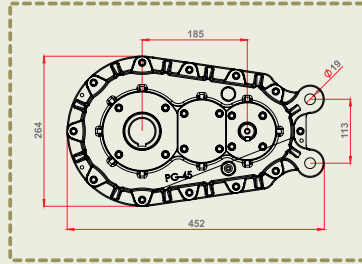

50 KADEMELİ REDÜKTÖR



Tip	PG-50
Tahvil Oranı	PG Kademeli
Kw	7,5 - 11
Hp	10 - 15
Termik Güç Kw	24
Nominal Tork (Nm)	1600
Çıkış Kovanı Ø	50
Giriş Mili Ø	32
Yağ Miktarı Lt.	4
Ağırlık Kg	34

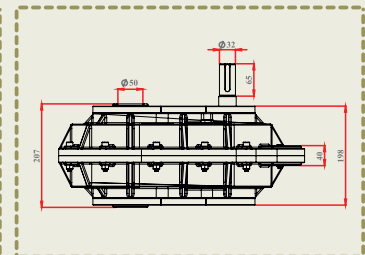
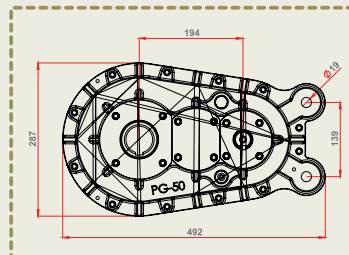

www.ozmakkonveyor.com

ÖZMAK



KONVEYÖR CONVEYORS

Redüktör / Reducer 55 KADEMELİ REDÜKTÖR

	PG-55
Tip	PG Kademeli
Tahvil Oranı	12/1
Kw	11 - 15
Hp	15 - 20
Termik Güç Kw	30
Nominal Tork (Nm)	2400
Çıkış Kovanı Ø	55
Giriş Mili Ø	42
Yağ Miktarı Lt.	6
Ağırlık Kg	48

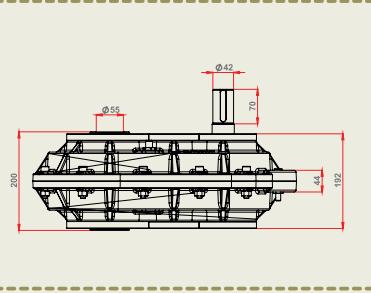
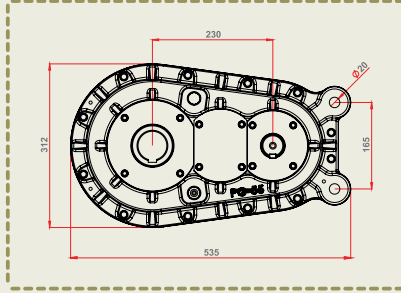

60 KADEMELİ REDÜKTÖR

	PG-60
Tip	PG Kademeli
Tahvil Oranı	12/1
Kw	15 - 18
Hp	20 - 24
Termik Güç Kw	40
Nominal Tork (Nm)	3600
Çıkış Kovanı Ø	60
Giriş Mili Ø	42
Yağ Miktarı Lt.	7
Ağırlık Kg	52

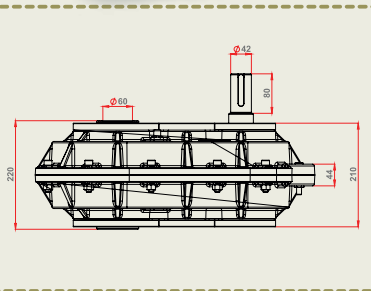
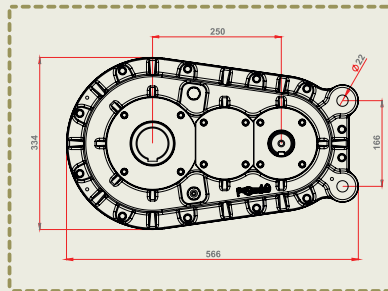

www.ozmakkonveyor.com

ÖZMAK



KONVEYÖR CONVEYORS

Redüktör / Reducer

70 KADEMELİ REDÜKTÖR

Tip	PG-70
Tahvil Oranı	PG Ağır Hizmet
Kw	22 - 25
Hp	30 - 35
Termik Güç Kw	60
Nominal Tork (Nm)	5200
Çıkış Kovanı Ø	70
Giriş Mili Ø	48
Yağ Miktarı Lt.	9
Ağırlık Kg	100

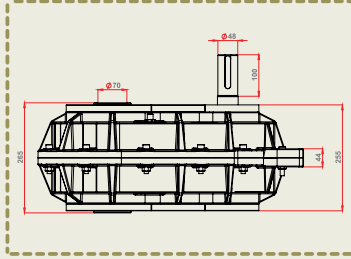
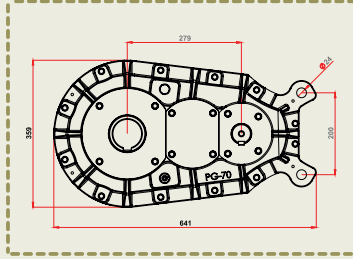

80 KADEMELİ REDÜKTÖR



Tip	PG-80
Tahvil Oranı	PG Ağır Hizmet
Kw	30 - 40
Hp	40 - 55
Termik Güç Kw	80
Nominal Tork (Nm)	7800
Çıkış Kovanı Ø	80
Giriş Mili Ø	55
Yağ Miktarı Lt.	12
Ağırlık Kg	150

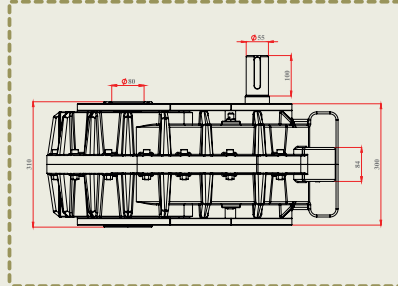
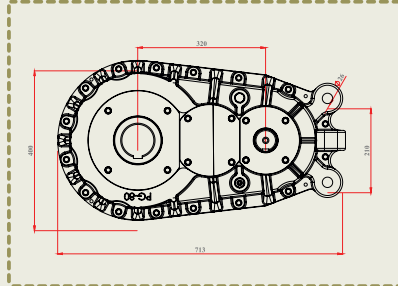

www.ozmakkonveyor.com

ÖZMAK



KONVEYÖR
CONVEYORS

Elek Teli / Steel Sieve

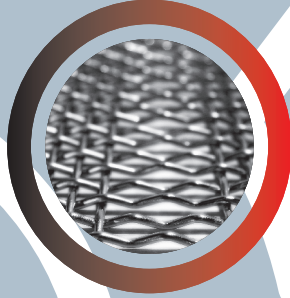

16 x 10 mm
(Tel \varnothing 5 mm)
saz elek

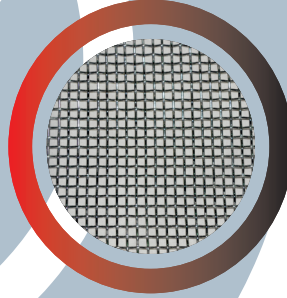

12 mm göz
(Tel \varnothing 4 mm)
eleme alanı : % 51 - 57 m

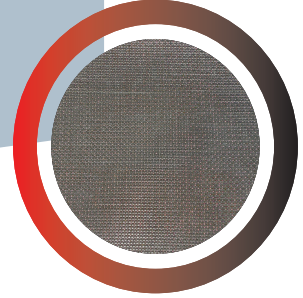

02 mm göz
(Tel \varnothing 1,5 mm)
eleme alanı : % 35 - 41 m

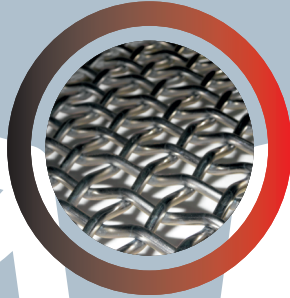

25 mm göz
(Tel \varnothing 6 mm)
eleme alanı : % 57 - 64 m

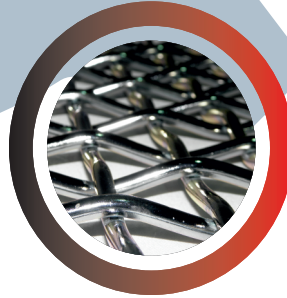

30 mm göz
(Tel \varnothing 8 mm)
eleme alanı : % 59 - 68 m

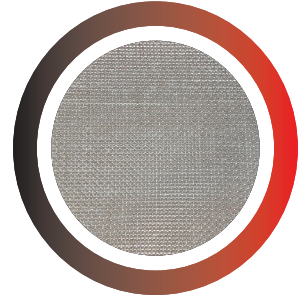

03 mm göz
(Tel \varnothing 2 mm)
eleme alanı : % 41 - 48 m

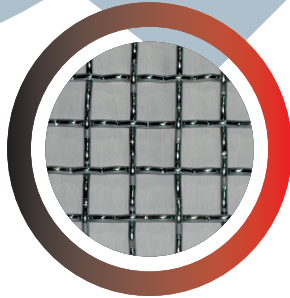

38 mm göz (atlamalı)
(Tel \varnothing 8 mm)
eleme alanı : % 57 - 68 m

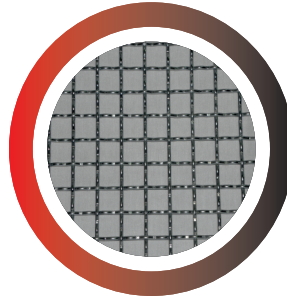

45 mm göz
(Tel \varnothing 8 mm)
eleme alanı : % 58 - 70 m
tek atkılı

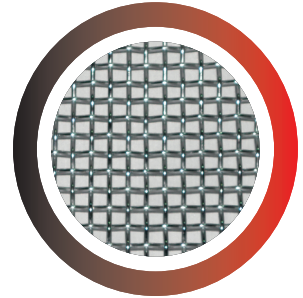

15 mm göz
(Tel \varnothing 5 mm)
eleme alanı : % 55 - 62 m

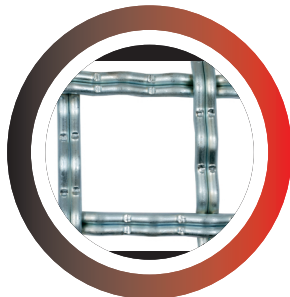

45 mm göz
(Tel \varnothing 5 mm)
eleme alanı : % 61 - 72 m
çift atkılı

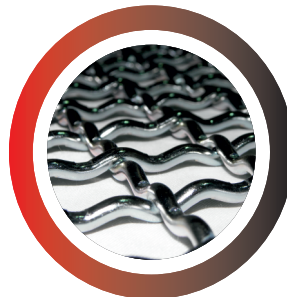

50 mm göz
(Tel \varnothing 8 mm)
eleme alanı : % 64 - 74 m

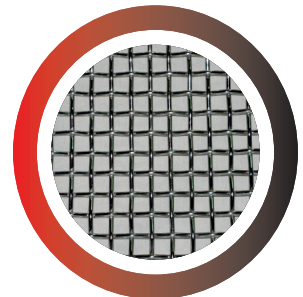

19 mm göz
(Tel \varnothing 5 mm)
eleme alanı : % 55 - 61 m

www.ozmakkonveyor.com

ÖZMAK



**KONVEYÖR
CONVEYORS**

**Konkasör Tesisi Döküm Yedek Parça
Crushing Plant Casting Spare Parts**

**Darbeli Kırıcı Yedek Parçaları
Impact Crusher Spare Parts**

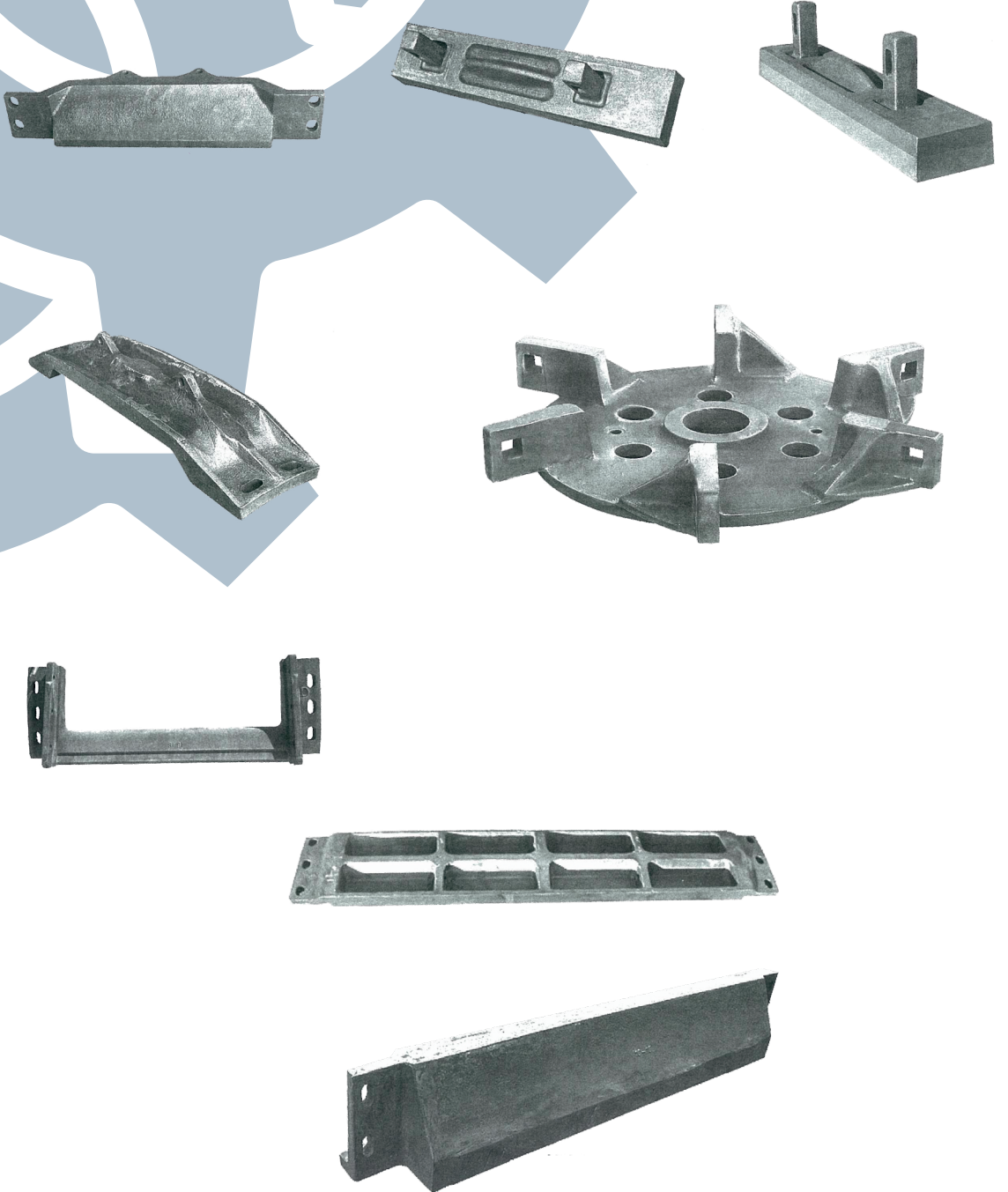

www.ozmakkonveyor.com

ÖZMAK



**KONVEYÖR
CONVEYORS**

**Konkasör Tesisi Döküm Yedek Parça
Crushing Plant Casting Spare Parts**

**Çeneli Kırıcı Yedek Parçaları
Jaw Crusher Spare Parts**

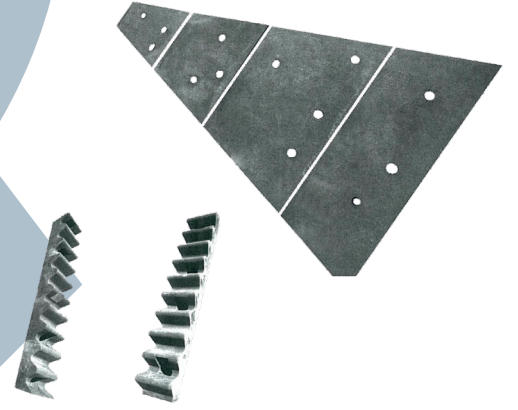

**110 Çeneli Kırıcı Yedek Parçaları
110 Jaw Crusher Spare Parts**

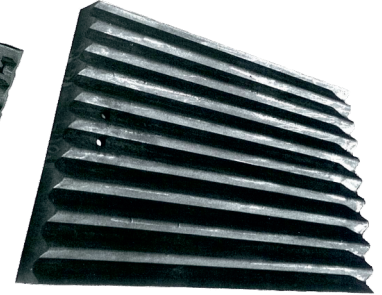
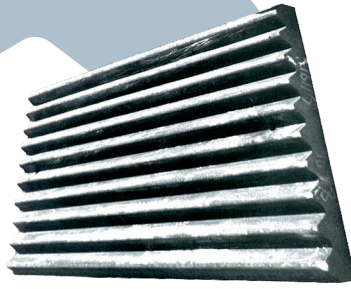

**90 Çeneli Kırıcı Yedek Parçaları
90 Jaw Crusher Spare Parts**

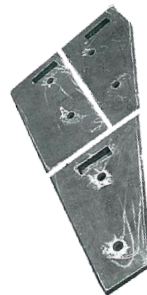
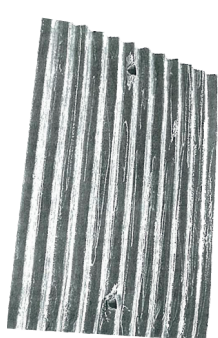

www.ozmakkonveyor.com

ÖZMAK



**KONVEYÖR
CONVEYORS**

Konkasör Tesisi Döküm Yedek Parça Crushing Plant Casting Spare Parts

Tersiyer Kırıcı Yedek Parçaları Tertiary Crusher Spare Parts

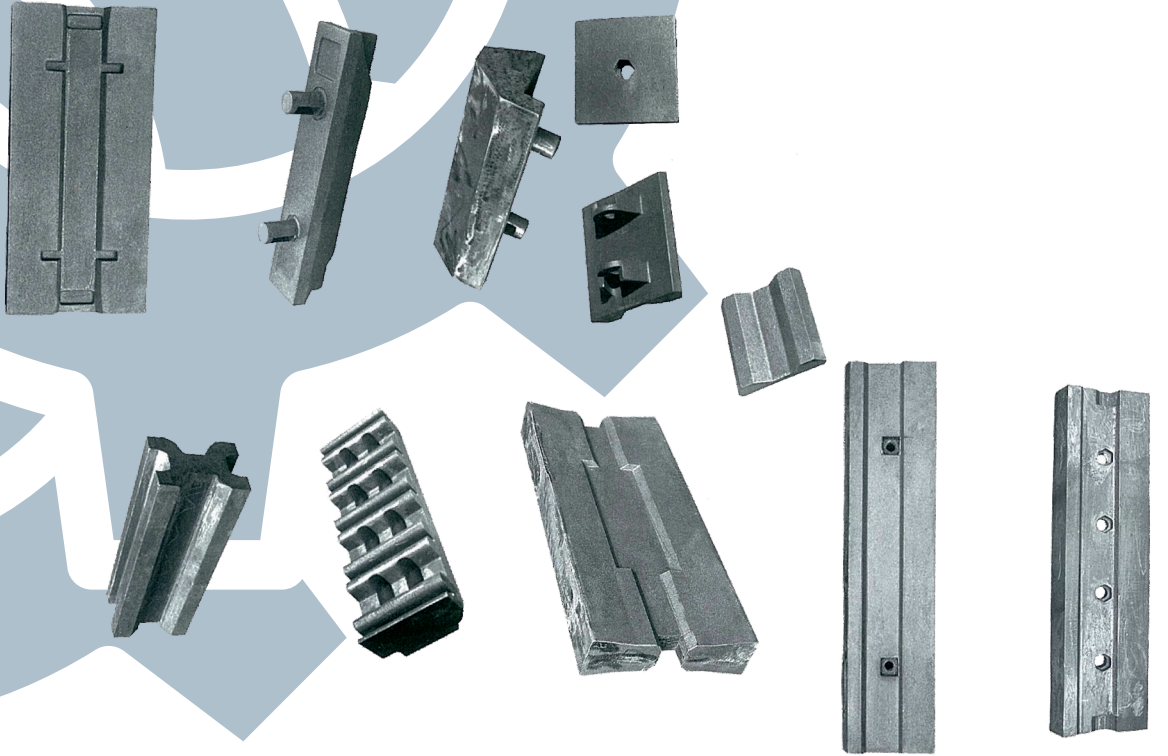

Diğer Kırıcı Yedek Parçaları Other Crusher Spare Parts

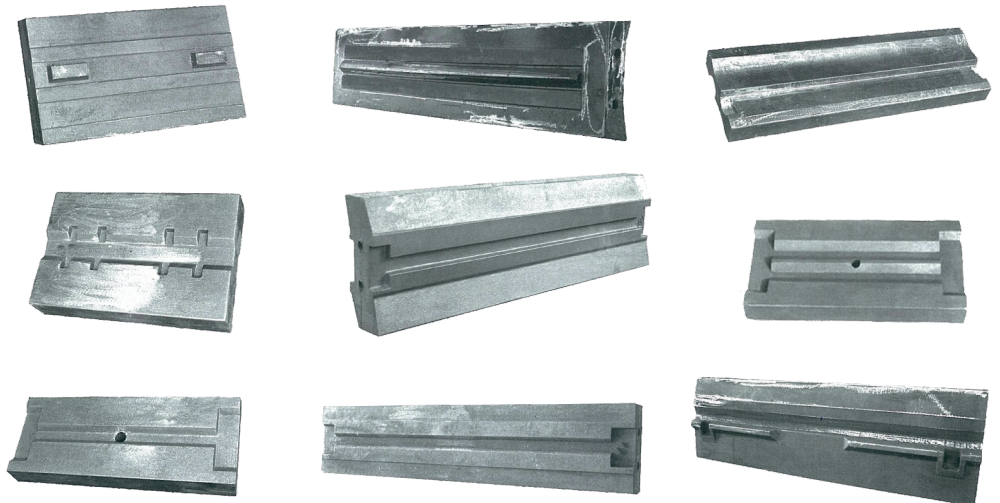

www.ozmakkonveyor.com

ÖZMAK



**KONVEYÖR
CONVEYORS**

**Konkasör Tesisi Döküm Yedek Parça
Crushing Plant Casting Spare Parts**

**Kum Makinesi Yedek Parçaları
Sand Machine Spare Parts**

www.ozmakkonveyor.com

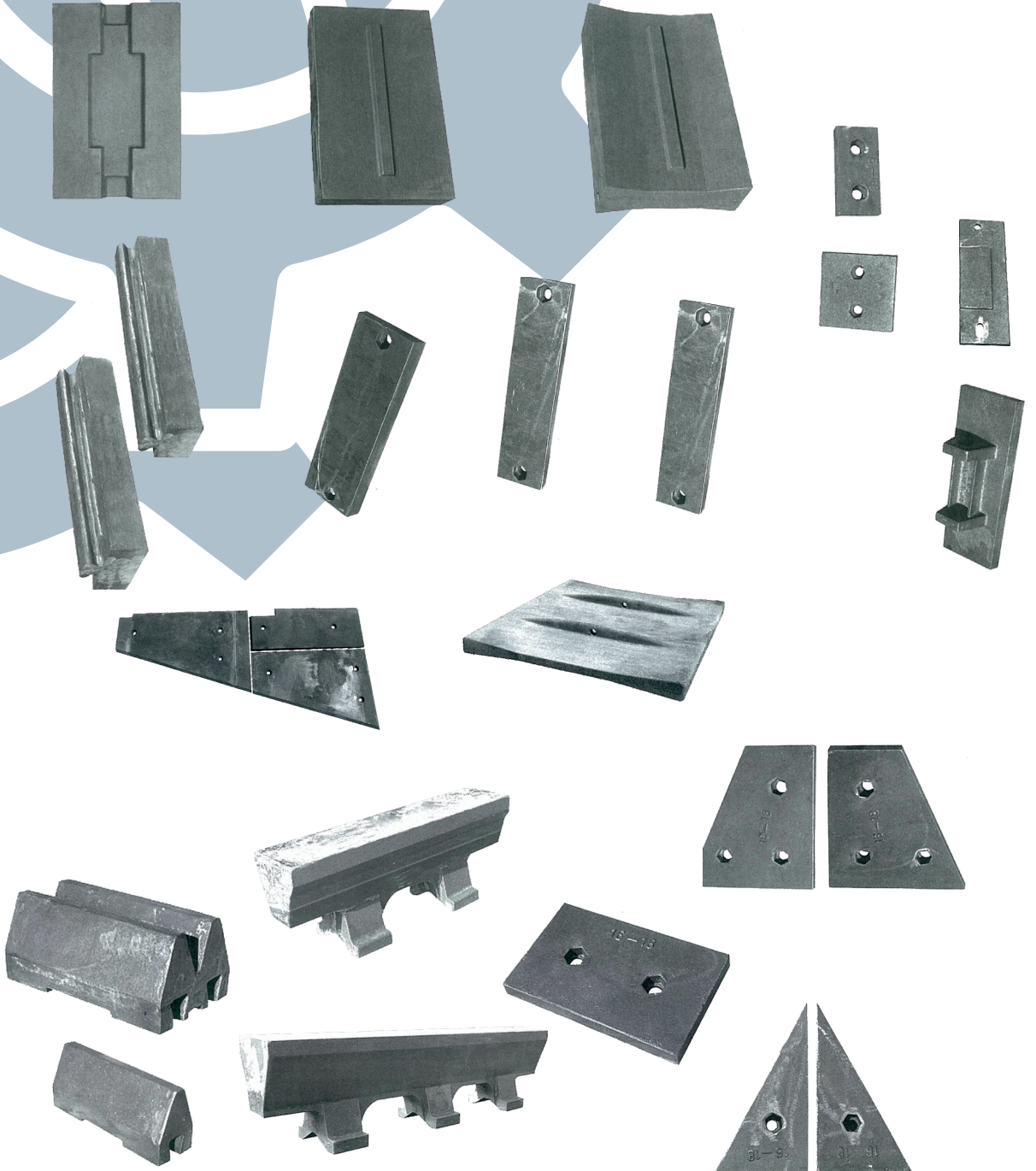

ÖZMAK





KONVEYÖR
CONVEYORS

www.ozmakkonveyor.com



ÖZMAK KONVEYÖR CONVEYORS

 +90 533 135 21 18

 +90 536 330 87 06

 İvedik O.S.B. Mah. 1397 .Sokak No : 1 / 41 Yenimahalle / Ankara

 info@ozmakkonveyor.com

 www.ozmakkonveyor.com

